



Integrated Grounding System

Simplified Grounding For Greater Safety & Lower Cost

Traditionally, solar modules are grounded by attaching lugs, bolts or clips to the module frame, then connecting these to a copper conductor that runs throughout the array. This process adds time and cost to the installation, and often results in improper grounding, creating significant long-term safety risks.

The IronRidge Integrated Grounding System solves these challenges by bonding modules directly to the mounting rails. This approach eliminates separate module grounding hardware, and it creates many parallel grounding paths throughout the array, providing greater safety for system owners.

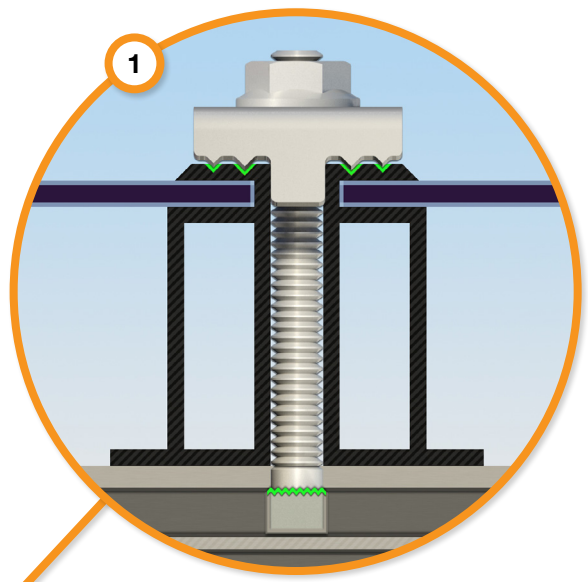

Grounding Mid Clamp

Each Grounding Mid Clamp pierces through the anodized coatings of both the module frame and the mounting rail to form secure electrical bonds, which are repeated throughout the array.

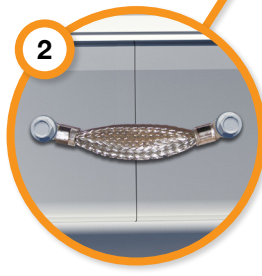
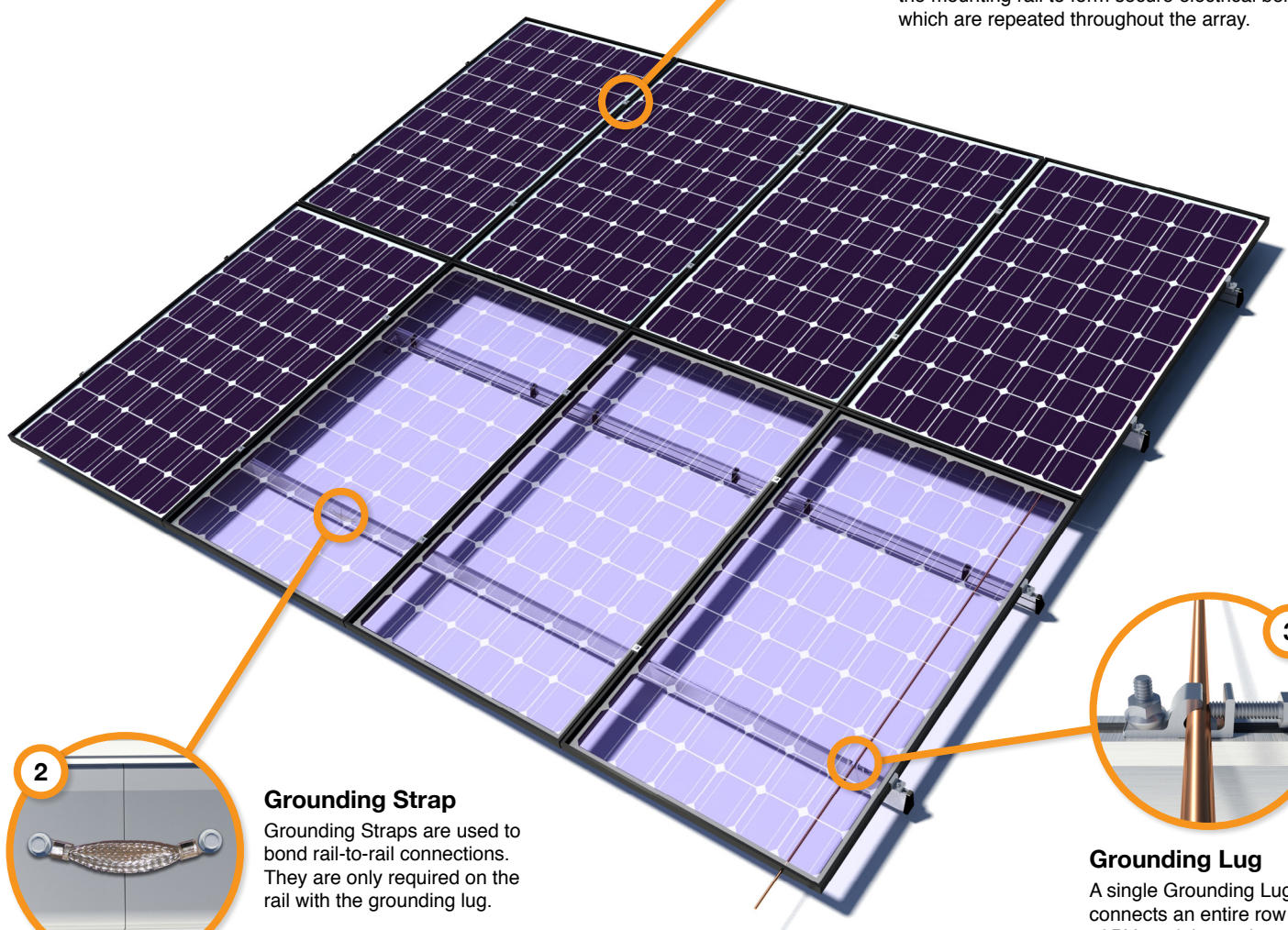

Grounding Strap
Grounding Straps are used to bond rail-to-rail connections. They are only required on the rail with the grounding lug.

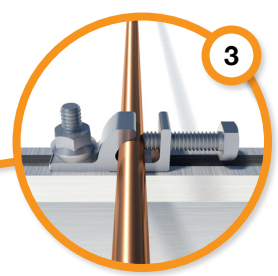

Grounding Lug
A single Grounding Lug connects an entire row of PV modules to the grounding conductor.

Installation Overview

1 Install Roof Attachments

- Install appropriate roof flashing and/or standoff for roof type.
- Attach L-Feet to flashing or standoff.

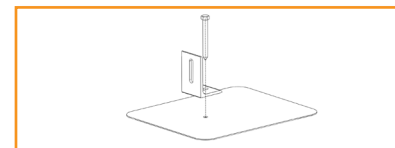

2 Prepare Rail Connections

- Insert splice into first rail, then secure with Grounding Strap and self-drilling screw.
- Slide second rail over splice, then secure with opposite end of Grounding Strap and self-drilling screw.

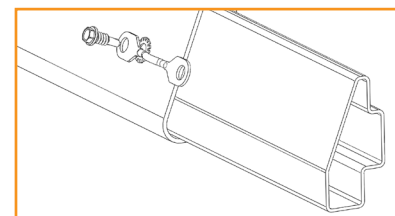

3 Mount & Ground Rails

- Attach rails to L-Feet and level rails.
- Install one Grounding Lug per row of modules.
- Connect Grounding Lug to grounding conductor.

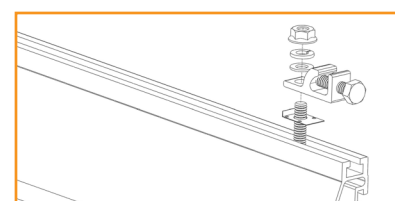

4 Install Modules & Clamps

- Install first module using End Clamps and Grounding Mid Clamps.
- Install additional modules using Grounding Mid Clamps.
- Finish row with a second pair of End Clamps.

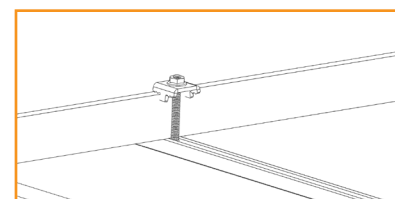

Testing & Certification

The IronRidge Integrated Grounding System has been tested and certified to UL 2703 by Intertek Group plc.

UL 2703 is a proposed UL standard for evaluating solar module mounting and clamping devices. It ensures these devices will maintain strong electrical and mechanical connections over an extended period of time in extreme outdoor environments.

The testing process closely mirrors that of UL 1703, the solar module testing standard, including temperature and humidity cycling, electrical and mechanical load testing, and manufacturing quality reviews.

Module Frame Compatibility

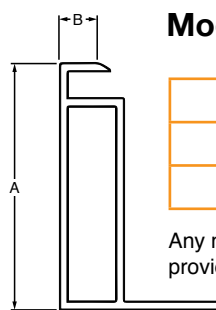

Dimension	Range
A	31.0mm - 51.0mm
B	5.08mm (minimum)

Any module frames whose parameters are not listed in the provided table have not been tested for compatibility.

The Grounding Clamp has proven robust in grounding 60-cell and 72-cell solar module frames with box construction and a range of anodization thicknesses.

All solar modules listed to UL 1703 and with frame construction within the parameters stated above are compatible with the IronRidge Integrated Grounding System.



Go to ironridge.com/ig